

()

INTERSTATE COUNCIL FOR STANDARDIZATION, METROLOGY AND CERTIFICATION
(ISC)

32489

2013



1.0-92 «
 1.2-2009 «
 1 «
 2 465 «
 3 (-
 14 2013 . 44-2013)

<	no (-
3166)004—97	3166)004—97	
	AM	
	KG	
	MD	-
	RU	
	TJ	

4 2013 . N9 2295- 01 32489-2013 17 -
 2014 .

5 « « ».
 « » ()
 « .

Safety belts for construction works. General specifications

—2014—11—01

1

1.1

() , , , .) , (-) , * (-) -

1.2

3 4.2.1-4.2.6. 4.3.1. 4.3.6. 4.3.10, 4.3.12. 4.3.13. 4.5.1-4.5.4. 4.6.2-4.6.7.8.2, 8.3

2

2.1

)

2.2

2.3

() .

2.4

2.5

2.6

2.7

2.8

2.9

2.10

- 2.11 : , -
- 2.12 : ,
- 2.13 : « ».
- 2.14 : (, , -
) ,
- 2.15 : , -
- 2.16 : ,
- 2.17 ; : -
- 2.18 () - , , .
- 3 ,
- 3.1 (-) ,
- 3.1.1 (-
)) 0.5
- 3.1.2 0.5 .
- 3.1.3 8 1 , 1-8 -

1

		-	DOM -
(11			
(2)			
1 [4	, , , *(3)	3	
1	- , . . . (4)		
1 >	{ 5)		
1 «	(dncvkox 61		

0.6 .

3.2
2.

2 XS XL

2

	S	780 1040
	L	» 940 » 1240 » 1140 » 1440

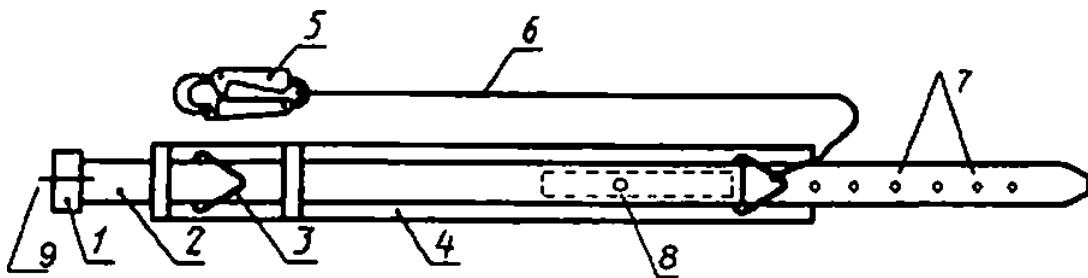

1- ; 2- ; 3- ; 4- ; 5- ; 6- ; 7- ; 8- ; 9-

1- , ()

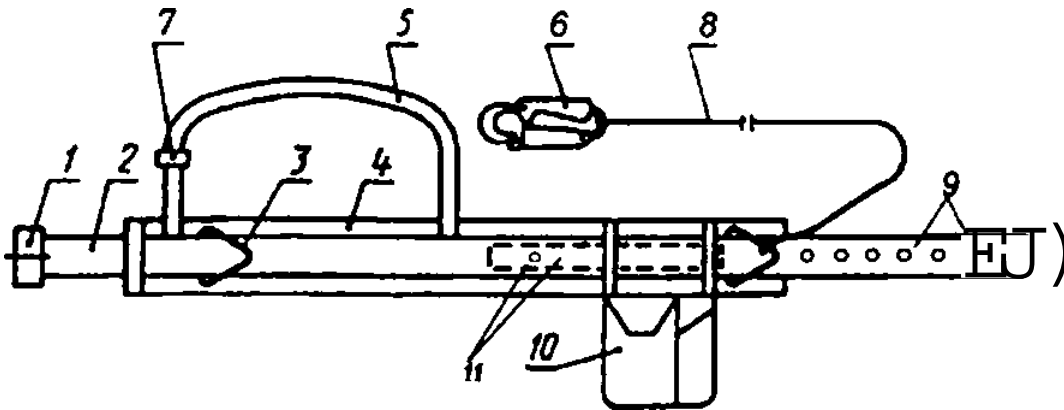

1- ; 2- ; 3- ; 4- ; 5- ; 6- ; 7- ; 8- ; 9- ; 10- ; 11-

2- , ()

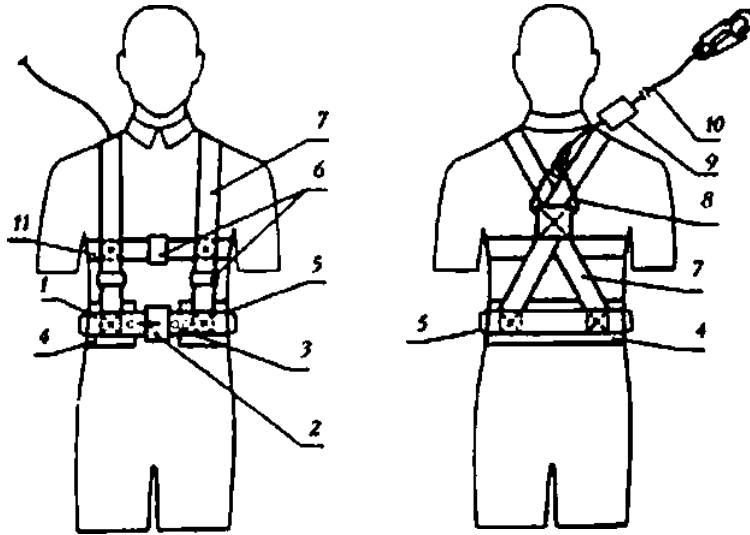

6 - 1 - ; 2 - ; 3 - ; 4 - ; 5 - ; 7 - ; 8 - ; 9 - ; 10 - () ; 11 - 3 - , 8 ()

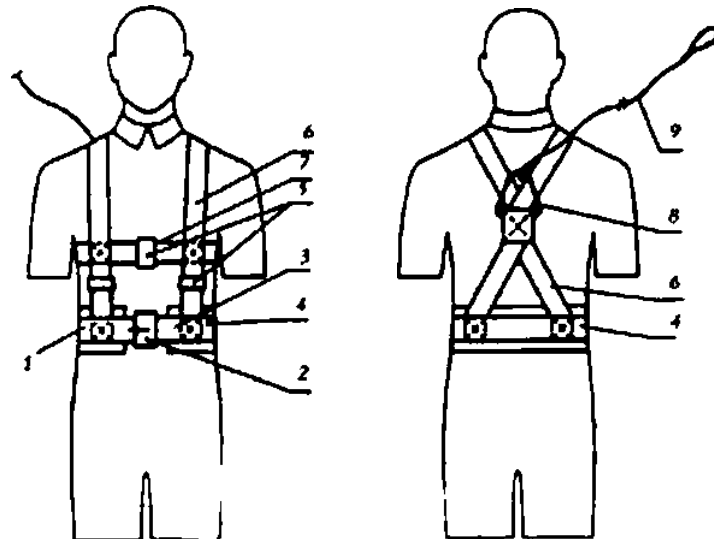

1 - ; 2 - ; 3 - ; 4 - ; 5 - ; 7 - ; 8 - ; 9 - 4 - ,

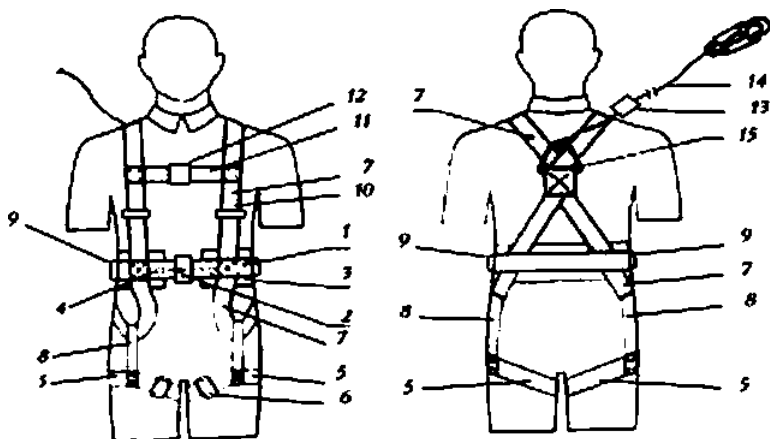

J- ;2- ;3- ;4- ;5-
 6- ;7- ;8-
 9 - ;10 - ;11 -
 12- ;13- ;14- { } ;
 75-
 5- ()

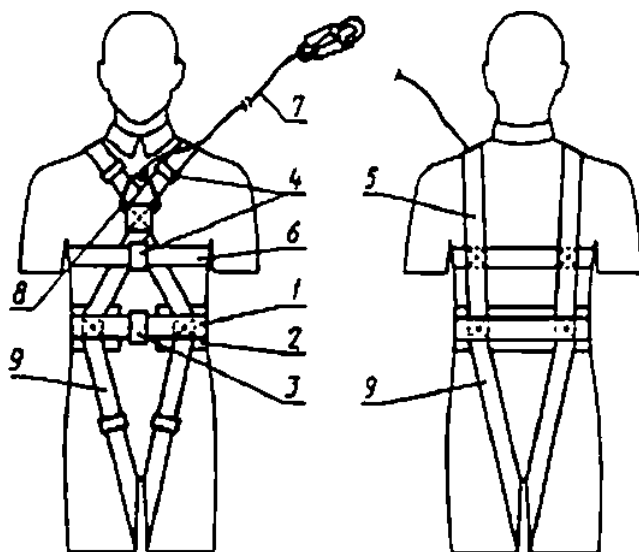

1 - ;2- ;3- ;4- ;5- ; -
 7- ;8- ;9-
 6- ()

3.3

- « »
- « »

56949,

S0849-2013

4

4.1

4.2

4.2.1

4.2.2

(10)

4.2.3

4.2.4

4.2.5

4.2.6

« - » 3 .

4.3

4.3.1

4.3.2

4.3.3

4.3.4

4.3.5

14 25 .

4.3.6

9 .

4.3.7

(,)

4.3.8

600 .

4.3.9

100 .

4.3.10		(, .) ,	
4.3.11	1700	2000	-
4.3.12			-
4.3.13			-
2.1	-3,0		
4.4			
4.5			
4.5.1	(1 0±1)		
4.5.2		10 (1000)	
4.5.3			-
•		-23 (2300)	
•	-15 (1500)		
-		5 (500)	
4.5.4			
•	6 (600)		
4.5.5			
4.5.6			
4.6			
4.6.1			-
4.6.2			-
4.6.3			-
4.6.4			-
4.6.5			-
4.6.6			-
		6 (600 ⁵)	
4.6.7			
4.6.8			-
	40°		

4.7

4.8

-
-
-
-

4.9

30

5

5.1

5.2

1000

-
-
-
-
-
-

5.3

-
-
-
-

5.4

5.5

5.6

6

6.1

-
-
-

• 4.2.1-4.2.7 -
 ; -
 •
 6.1.1 100 / - 2 -
 6.1.2 () -
 6.1.3 () (100±1) -
 6.1.4 4.5.2 12% -
 7. 4.5.3 () -
 8. -
 8. -
 4.5.2 4.5.3 (50011)
 2 X L 1.0
 3

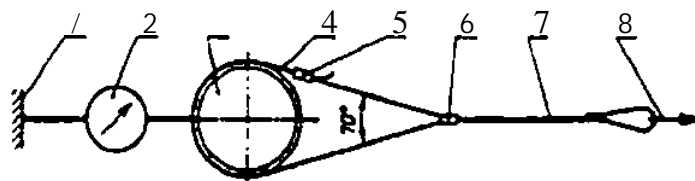

1- ; 2- ; 3- 300 ; 4- ;
 5- ; 6- ; 7- ; -

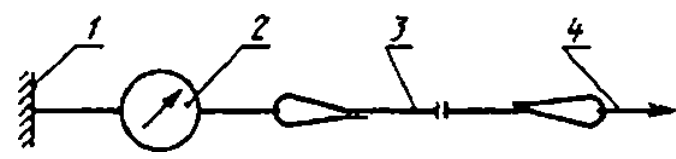

1 ; 2• 4 ; 3• ;
 8•

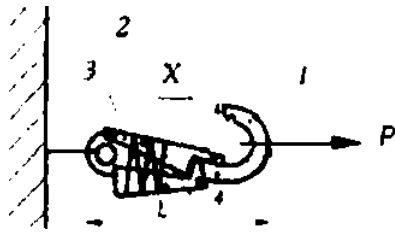

1- ; 2- ; 3- ;
 4- 1-1.5 (500*1) ; X- ;

L -

8 -

6.1.5

9 10.

4.5.1

()

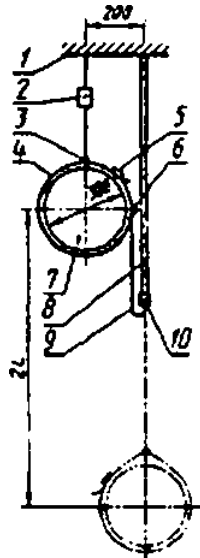

f- ; 2- ; 3- ; 4- ;
 5- ; 7- () ; 8- ; 9- ;
 10 -

9-

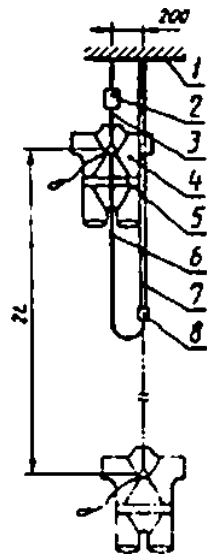

1- :2- :3- ;7- :8- :4- :5- :

10-

6.1.6

6.1.5.

4.5.4

()

4.5.4.

. 4.5.4.

4.5.4

« ».

« » « »- 5.7 (570).

3.7 (370).

7

7.1

7.2

(, .).

7.3

(70 %) -

7.4

8

8.1

8.2.

8.3

•

•

•

•

8.4

8.5

8.6

3

1.5

8.7

15 (1500).

9

9.1

9.2

9.3

687.386-783.4:006.354

13.340.99

:	,	,	,	,	,	,	,	,	,	.
,	,	,	,	,	,	,	,	,	,	-
.	,									

01.09.2014. 60x84Vs.
. . . 1,86. 48 . . 3273.

« »
123995 . .. 4.
www.90stinlo.ru info@gostinfo.ru